

FIRE RESISTANT INTERNAL DOOR FD18

Description:

Hinged timber leaf hung in timber frame.

The door is intended to use for closing entrances between the fire compartments of heated working and living premises. The difference of temperature of the rooms so separated cannot exceed 5 °C.

Performance characteristics:

Fire resistance: EI₃₀

Smoke control: Sa/S₂₀₀ (single-leaf, without glazing)

Self-closing: C0

Sound insulation: Rw 38dB (single-leaf, without glazing)*

Technical data:

Dimensions: Single-leaf: M7-M10 x M21 (max M10 x M22).
Double-leaf: M15-M20 x M21 (max M20 x M22).
Special dimensions available on request.

Door leaf: Door leaf thickness 54 mm. Decoration is flush, possible to order decorative boards and/or slits, grooved pattern (depth up to 1,7mm).

Glazing: Glass opening max dimensions 733 mm x 1920 mm, glass Fireswiss Foam 30-15, painted wooden glazing bead, fixing with screws.

Frame: Softwood frame 42x92 mm, profile FR435 or FR435N.

Threshold: In standard hardwood threshold, height 25 mm, type RO. Also available with height 22 mm or 20 mm and automatic threshold.

Finishing: Door leaf and frame painted white (NCS S 0502-Y), special colors by catalogues.

Fittings: In standard Assa 565 lock case and adjustable striker plate 0094 (see also alternative fittings for fire- and smoke resistant doors ASL-08-0001).

Hinges: Abloy 3248-110 TMKSS (3 pcs) or 110 x36 KSS (3 pcs)

Accessories:

- RST kick plate
- extra security lock ASSA 411 or Abloy 4181
- doorbell Abloy DF64
- door eye Y180
- door closer Abloy DC335+DC199, Dorma TS 73, TS 93 or ITS 96 2-4+G96 N20 P
- coordinator Olda 30DK
- lead cover and cable Abloy EA281
- key tube ASSA 88
- panic bar (surface mounted)
- flush bolt, automatic Olda 28HZ, Olda 30HZ or manual Oda 31HZ-C

Certificates: kiwa Certificate of Conformity no. ET-0221-18 (Inspecta Estonia OÜ)

Packing: Door leaf packed with frame. Edges covered with protective board and door coated with plastic.

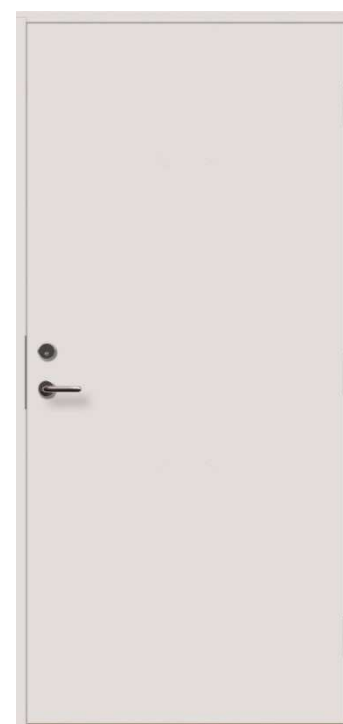

KIWA certified
ET-0221-18

FD18

EI₃₀
C0
S_a/S₂₀₀

VILJANDI 
Viljandi, Estonia
2019
ID:123456-1

FD18

Rw 38dB

VILJANDI 
Viljandi, Estonia
2019
ID:123456-1

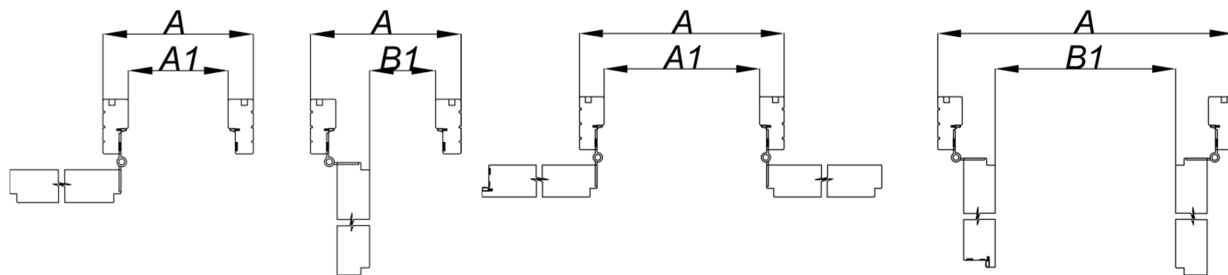

Module	A (mm)	A1 (mm)	B (mm)	B1 (mm)	C (mm)	D (mm)
Single-leaf M9 x 21	890	806	825	750	2090	2040
Single-leaf M10 x 21	990	906	925	850	2090	2040
Double-leaf M19,3 x 21	1917	1833	925+925	1720	2090	2040
Double-leaf M20 x 21	1990	1906	968+955	1793	2090	2040

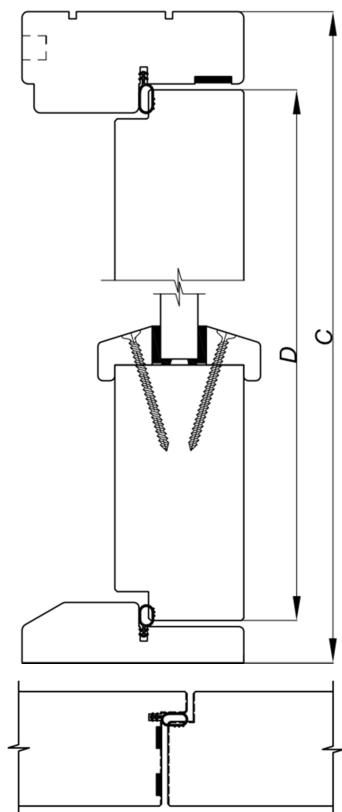
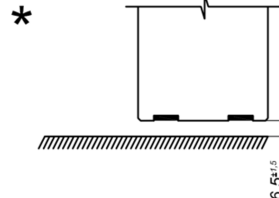
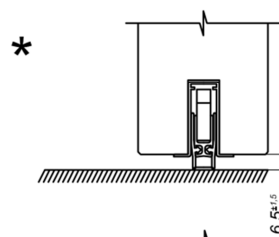
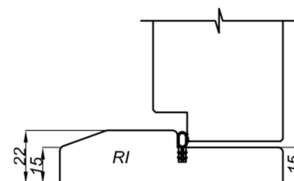
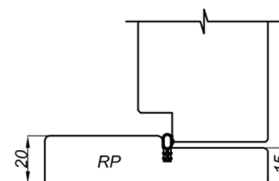
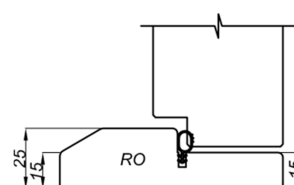
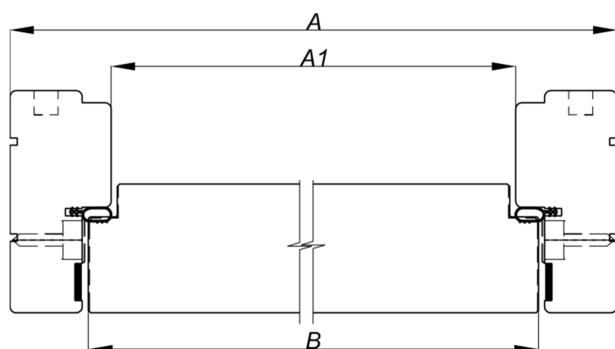

* Not allowed for double-leaf doors.

Construction without threshold is not allowed for single-leaf sound proof doors.